

Alvarado Sub Courthouse

Approved by CC:

JUN 09 2014

Items	Amount
Furniture	\$44,328.45
Pews	\$14,500.00
IT	\$20,000.00
Refrigerator	\$650.00
Gun Safe	\$1,000.00
Total	\$80,478.45

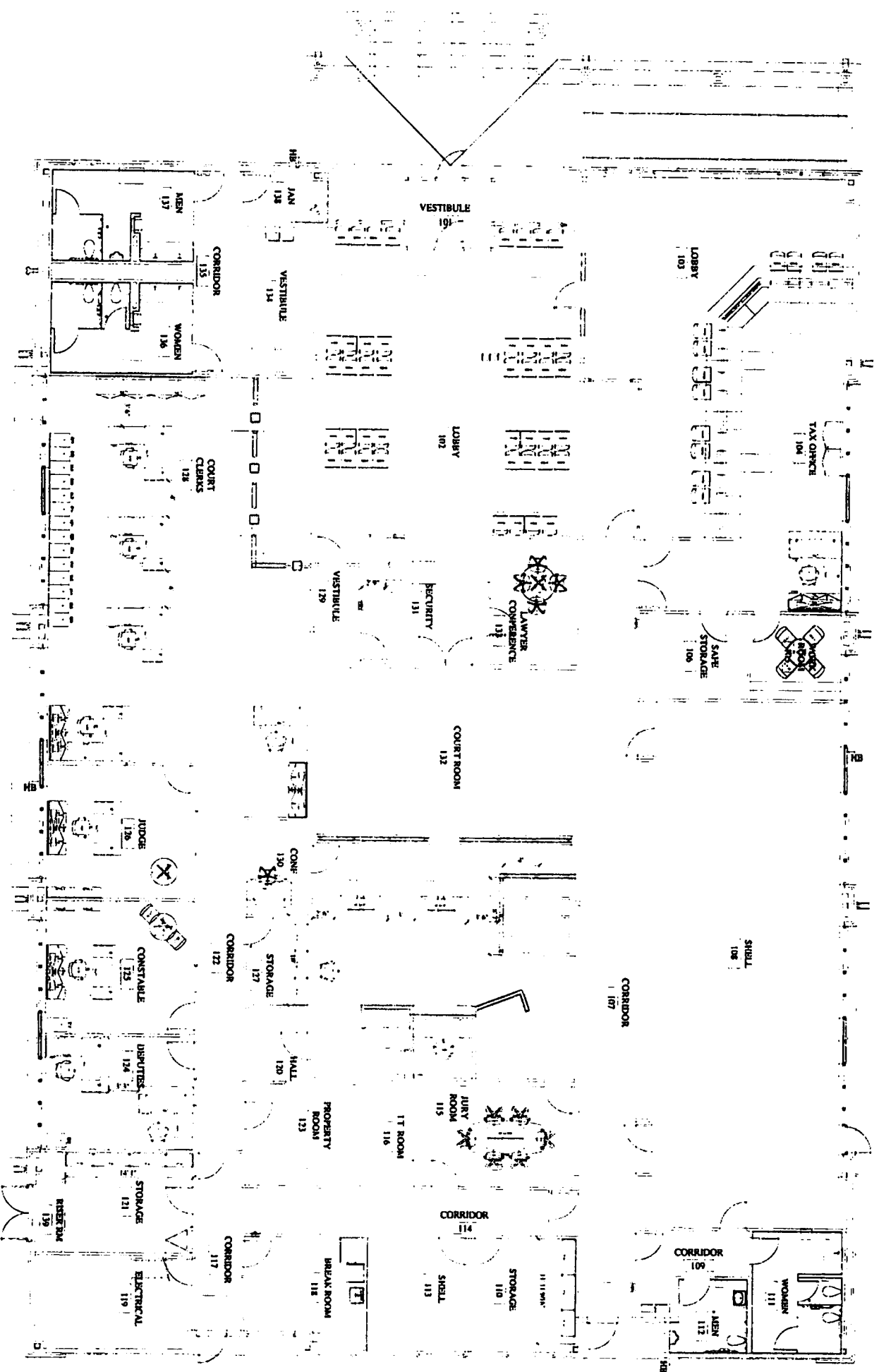

Office Depot - Hon 10500
 05.22.14

Item	Preview	Mfg	Part Number	Part Description	Qty	Sell	Ext Sell
1		HON	H4048	Olson Stacker 4040 Series Ganging Ctr Glides(Box of 48)	3	\$ 48.88	\$ 146.64
2		HON	H4041	Olson Stacker 4040 Series Polymer Seat&Back 4-per cmt	11	\$ 278.24	\$ 3,060.64
			.RE .Y	COLOR: Regatta FRAME: Chrome			
sub				102 Lobby Subtotal			\$ 3,207.28
3		HON	H4041	Olson Stacker 4040 Series Polymer Seat&Back 4-per cmt	3	\$ 278.24	\$ 834.72
			.RE .Y	COLOR: Regatta FRAME: Chrome			
sub				103 Lobby Subtotal			\$ 834.72
4		HON	HR1870980	Tasklight 60W	1	\$ 101.52	\$ 101.52
5		HON	H105856	10500 Series Back enclosure for 72\"/>	1	\$ 94.47	\$ 94.47
			.F	LAM: Shaker Cherry			
6		HON	H105896L	10500 Series 72Wx36Dx29-1/2H SglPedDskLH B/B/F RectTop	1	\$ 563.53	\$ 563.53
			.F F	LAM: Shaker Cherry LAM: Shaker Cherry			
7		HON	H10570	10500 Series Bridge 47W x 24D x 29-1/2H	1	\$ 149.46	\$ 149.46
			.F F	LAM: Shaker Cherry LAM: Shaker Cherry			
8		HON	H105903R	10500 Series 72Wx24Dx29-1/2H Single Ped Cred RH F/F Ped	1	\$ 501.02	\$ 501.02
			.F F	LAM: Shaker Cherry LAM: Shaker Cherry			
9		HON	H105493	10500 Series 72Wx24Dx29-1/2H Cred w/Two Storage Cab	1	\$ 668.34	\$ 668.34
			.F F	LAM: Shaker Cherry LAM: Shaker Cherry			
10		HON	H10534K	10500 Series 72x37 1/8 Stack-On Storage 4-Dr Locking ETA	1	\$ 447.44	\$ 447.44
			.F F	LAM: Shaker Cherry LAM: Shaker Cherry			
11		HON	H80056	10500 Series Tckbd for 72\"/>	1	\$ 118.91	\$ 118.91
			\$(2) .GN 53	GRADE: Fabric Grade II Fabric: Element COLOR: Parchment			

Approved _____

Date _____

Quote prices are subject to manufacturer price increases.









QUOTE IS SUBJECT TO FINAL AUDIT

All product is special order and therefore non-returnable and non-refundable.

Orders over \$5000 require credit approval.

Orders over \$20,000 require credit approval and 1/3 deposit.

QUOTE VALID FOR 30 DAYS

Item	Preview	Mfg	Part Number	Part Description	Qty	Sell	Ext Sell
12		GLB	5450-3 -03 -JENY JN02 SC BK C1 ~ ~ ~	TRUFORM-High back multi tilter w/ hgt adj arms, ratchet-style back height seat depth adj GRADE 03 JENNY 1-EBONY A-(STD) HGT ADJ SSU F-(STD) BLACK C-(STD) 2" DUAL-WHL CASTOR - BLCK (STD) (STD) (STD)	1	\$ 305.03	\$ 305.03
sub				104 Tax Office Subtotal			\$ 2,949.72
13		HON	HBBX36 _P	Hospitality Tbl 3" Dia. Single Column Base 36" x 36" Color: Black	1	\$ 101.05	\$ 101.05
14		HON	H1121 _F _P	Hospitality Tbl Rnd Hosp Top w/ T-Mid Edg 36" Dia Lam: Shaker Cherry T-Mold: Black	1	\$ 107.16	\$ 107.16
15		HON	H4041 _RE _Y	Olson Stacker 4040 Series Polymer Seat&Back 4-per crnt COLOR: Regatta FRAME: Chrome	1	\$ 278.24	\$ 278.24
sub				105 Work Room Subtotal			\$ 486.45
16		SAF	5276	18 x 36" Wire Shelving Starter Unit	1	\$ 174.99	\$ 174.99
17		SAF	5241	18 x 48" Wire Shelving Starter Unit	2	\$ 195.29	\$ 390.58
sub				110 Storage Subtotal			\$ 565.57
18		HON	HTLCP96 _F	Preside Laminate Curved Panel Base For 96" W Table Tops LAM: Shaker Cherry	1	\$ 259.44	\$ 259.44
19		HON	HVL801 S(L) _ST 11	Managerial High-back PneuTilt Tension Loop Arms GRADE: Leather UPHOLSERY UPH: Leather COLOR: Black 11	6	\$ 104.81	\$ 628.86
20		HON	HTLB4896 _G F _N _F	Preside 96W x 48D Boat Shaped Laminate Top 2MM/Flat LAM: Shaker Cherry No Grommets LAM: Shaker Cherry	1	\$ 348.27	\$ 348.27
sub				115 Jury Room Subtotal			\$ 1,238.57

Approved _____

Date _____

Quote prices are subject to manufacturer price increases.











QUOTE IS SUBJECT TO FINAL AUDIT

All product is special order and therefore non-returnable and non-refundable.

Orders over \$5000 require credit approval.

Orders over \$20,000 require credit approval and 1/3 deposit.

QUOTE VALID FOR 30 DAYS









Item	Preview	Mfg	Part Number	Part Description	Qty	Sell	Ext Sell
21		SAF	5241	18 x 48" Wire Shelving Starter Unit	2	\$ 185.29	\$ 390.58
22		SAF	5276	18 x 36" Wire Shelving Starter Unit	2	\$ 174.89	\$ 349.88
sub				121 Storage Subtotal			\$ 740.56
23		HON	H105896L .F F	10500 Series 72Wx36Dx29-1/2H Sgl PedDskLH B/B/F RectTop LAM: Shaker Cherry LAM: Shaker Cherry	1	\$ 563.53	\$ 563.53
24		HON	H105895R .F F	10500 Series 48Wx24Dx29-1/2H Return Rt File/File Ped LAM: Shaker Cherry LAM: Shaker Cherry	1	\$ 398.09	\$ 398.09
25		HON	H105895R .F F	10500 Series 72Wx36Dx29-1/2H Sgl edDskRH B/B/F RectTop LAM: Shaker Cherry LAM: Shaker Cherry	1	\$ 563.53	\$ 563.53
26		HON	H105906L .F F	10500 Series 48Wx24Dx29-1/2H Return Lt File/File Ped LAM: Shaker Cherry LAM: Shaker Cherry	1	\$ 398.09	\$ 398.09
27		HON	H315C .P \$(CORE) .L	310 Series Vertical File 5 Drawer Legal w/Lock Standard Random Key Lock PAINT: Select Core Paint PAINT: Putty	1	\$ 394.33	\$ 394.33
28		GLB	5450-3 -03 ~JENY JN02 SC BK C1 ~ ~ ~ ~	TRUFORM-High back multi tilter w/ hgt adj arms, ratchet-style back height seat depth adj GRADE 03 JENNY 1-EBONY A-(STD) HGT ADJ SSU F-(STD) BLACK C-(STD) 2" DUAL-WHL CASTOR - BLCK (STD) (STD) (STD) (STD)	2	\$ 305.03	\$ 610.06
sub				124 Deputies Subtotal			\$ 2,927.83
29		HON	HR870980	Tasklight 60W	1	\$ 101.52	\$ 101.52
30		HON	HTLXP36 .F	Preside Laminate Curved Panel X Base for 36" Tops LAM: Shaker Cherry	1	\$ 188.59	\$ 188.59

Approved _____

Date _____

Quote prices are subject to manufacturer price increases.
QUOTE IS SUBJECT TO FINAL AUDIT
All product is special order and therefore non-returnable and non-refundable.
Orders over \$5000 require credit approval.
Orders over \$20,000 require credit approval and 1/3 deposit.

QUOTE VALID FOR 30 DAYS

Item	Preview	Mfg	Part Number	Part Description	Qty	Sell	Ext Sell
31		HON	H105856 . .F	10500 Series Back enclosure for 72"W Stack on Storage LAM: Shaker Cherry	1	\$ 94.47	\$ 94.47
32		HON	H105890 . .F F	10500 Series 72Wx36Dx29-1/2H Dbl Ped Dsk 3/2 Rect Top LAM: Shaker Cherry LAM: Shaker Cherry	1	\$ 704.53	\$ 704.53
33		HON	H105900 . .F F	10500 Series Cred w/Kneespace 72Wx24Dx29-1/2H 2-0-2 LAM: Shaker Cherry LAM: Shaker Cherry	1	\$ 617.58	\$ 617.58
34		HON	H105535 . .F F	10500 Series Bookcase 5-shelf 36Wx13-1/8Dx71H LAM: Shaker Cherry LAM: Shaker Cherry	2	\$ 328.06	\$ 656.12
35		HON	H10534K . .F F	10500 Series 72x37 1/8 Stack-On Storage 4-Dr Locking ETA LAM: Shaker Cherry LAM: Shaker Cherry	1	\$ 447.44	\$ 447.44
36		HON	H90056 S(2) .GN 53	10500 Series Tckbd for 72"W Stack on Strg Bck Enclosure GRADE: Fabric Grade II Fabric: Element COLOR: Parchment	1	\$ 118.91	\$ 118.91
37		HON	H315C . P S(CORE) L	310 Series Vertical File 5 Drawer Legal w/Lock Standard Random Key Lock PAINT: Select Core Paint PAINT: Putty	1	\$ 394.33	\$ 394.33
38		HON	H4073 S(3) .NT 10 .T	Pagoda 4070 Series Fan Back Guest Armless Set of 2 GRADE: III UPHOLSTERY UPH: Tectonic COLOR: Black FRAME: Black	1	\$ 261.79	\$ 261.79
39		HON	HTLD36 . .K F .N .F	Preside 36" Round Shaped Laminate Top Ribbon LAM: Shaker Cherry No Grommets LAM: Shaker Cherry	1	\$ 234.06	\$ 234.06

Approved _____

Date _____

Quote prices are subject to manufacturer price increases.









QUOTE IS SUBJECT TO FINAL AUDIT

All product is special order and therefore non-returnable and non-refundable.

Orders over \$5000 require credit approval.

Orders over \$20,000 require credit approval and 1/3 deposit.

QUOTE VALID FOR 30 DAYS

Item	Preview	Mfg	Part Number	Part Description	Qty	Sell	Ext Sell
40		HON	HN1 .A .H .IM \$(3) .NT 10 .SB .T	Nucleus Mid Back Work Chair Arm: Adjustable Arm Caster: Hard Back: Stretch Black GRADE: III UPHOLSTERY UPH: Tectonic COLOR: Black Base: Standard Plastic Black FRAME: Black	1	\$ 396.21	\$ 396.21
sub				125 Constable Subtotal			\$ 4,213.55
41		HON	H14870960	Tasklight 60W	1	\$ 101.52	\$ 101.52
42		HON	HTLCXP36 .F	Preside Laminare Curved Panel X Base for 36" Tops LAM: Shaker Cherry	1	\$ 186.59	\$ 186.59
43		HON	H105856 .F	10500 Series Back enclosure for 72"W Stack on Storage LAM: Shaker Cherry	1	\$ 94.47	\$ 94.47
44		HON	H105890 .F F	10500 Series 72Wx36Dx29-1/2H Dbl Ped Dsk 3/2 Rect Top LAM: Shaker Cherry LAM: Shaker Cherry	1	\$ 704.53	\$ 704.53
45		HON	H105900 .F F	10500 Series Crad w/Kneespace 72Wx24Dx29-1/2H 2-0-2 LAM: Shaker Cherry LAM: Shaker Cherry	1	\$ 617.58	\$ 617.58
46		HON	H105535 .F F	10500 Series Bookcase 5-shelf 36Wx13-1/8Dx71H LAM: Shaker Cherry LAM: Shaker Cherry	2	\$ 328.06	\$ 656.12
47		HON	H10534K .F F	10500 Series 72x37 1/8 Stack-On Storage 4-Dr Locking ETA LAM: Shaker Cherry LAM: Shaker Cherry	1	\$ 447.44	\$ 447.44
48		HON	H90056 \$(2) .GN 53	10500 Series Tckbd for 72"W Stack on Strg Bck Enclosure GRADE: Fabric Grade II Fabric: Element COLOR: Parchment	1	\$ 118.91	\$ 118.91

Approved _____

Date _____

Quote prices are subject to manufacturer price increases.









QUOTE IS SUBJECT TO FINAL AUDIT

All product is special order and therefore non-returnable and non-refundable.

Orders over \$5000 require credit approval.

Orders over \$20,000 require credit approval and 1/3 deposit.

QUOTE VALID FOR 30 DAYS

Item	Preview	Mfg	Part Number	Part Description	Qty	Sell	Ext Sell
49		HON	HTLD36 .K F .N .F	Preside 36" Round Shaped Laminate Top Ribbon LAM: Shaker Cherry No Grommets LAM: Shaker Cherry	1	\$ 234.06	\$ 234.06
50		HON	HNT .A .H .JM \$(3) .NT 10 .SB .T	Nucleus Mid Back Work Chair Arm: Adjustable Arm Caster: Hard Back: Stretch Black GRADE: III UPHOLSTERY UPH: Teclonic COLOR: Black Base: Standard Plastic Black FRAME: Black	1	\$ 396.21	\$ 396.21
sub				126 Judge Subtotal			\$ 3,557.43
51		SAF	5276	18 x 36" Wire Shelving Starter Unit	3	\$ 174.99	\$ 524.97
sub				127 Storage Subtotal			\$ 524.97
52		HON	HH870980	Tasklight 60W	2	\$ 101.52	\$ 203.04
53		HON	H105856 .F	10500 Series Back enclosure for 72"W Stack on Storage LAM: Shaker Cherry	2	\$ 94.47	\$ 188.94
54		HON	H105906L .F F	10500 Series 48Wx24Dx29-1/2H Return Li File/File Ped LAM: Shaker Cherry LAM: Shaker Cherry	3	\$ 398.09	\$ 1,194.27
55		HON	H105895R .F F	10500 Series 72Wx36Dx29-1/2H Sgl edDskRH B/B/F RecITop LAM: Shaker Cherry LAM: Shaker Cherry	3	\$ 563.53	\$ 1,690.59
56		HON	H105493 .F F	10500 Series 72Wx24Dx29-1/2H Cred w/Two Storage Cab LAM: Shaker Cherry LAM: Shaker Cherry	3	\$ 668.34	\$ 2,005.02
57		HON	H105896L .F F	10500 Series 72Wx36Dx29-1/2H SglPedDskLH B/B/F RecITop LAM: Shaker Cherry LAM: Shaker Cherry	2	\$ 563.53	\$ 1,127.06

Approved _____

Date _____

Quote prices are subject to manufacturer price increases.







QUOTE IS SUBJECT TO FINAL AUDIT

All product is special order and therefore non-returnable and non-refundable.

Orders over \$5000 require credit approval.

Orders over \$20,000 require credit approval and 1/3 deposit.

QUOTE VALID FOR 30 DAYS

Item	Preview	Mfg	Part Number	Part Description	Qty	Sell	Ext Sell
58		HON	H10570 .F F	10500 Series Bridge 47W x 24D x 29-1/2H LAM: Shaker Cherry LAM: Shaker Cherry	1	\$ 149.46	\$ 149.46
59		HON	H105903R .F F	10500 Series 72Wx24Dx29-1/2H Single Ped Cred RH F/F Ped LAM: Shaker Cherry LAM: Shaker Cherry	1	\$ 501.02	\$ 501.02
60		HON	H10534K .F F	10500 Series 72x37 1/8 Stack-On Storage 4-Dr Locking ETA LAM: Shaker Cherry LAM: Shaker Cherry	2	\$ 447.44	\$ 894.88
61		HON	H105905R .F F	10500 Series 48Wx24Dx29-1/2H Return Rt File/File Ped LAM: Shaker Cherry LAM: Shaker Cherry	1	\$ 398.09	\$ 398.09
62		HON	H90056 \$(2) .GN 53	10500 Series Tckbd for 72"W Stack on Strg Bck Enclosure GRADE: Fabric Grade II Fabric: Element COLOR: Parchment	2	\$ 118.91	\$ 237.82
63		HON	H315C .P \$(CORE) .L	310 Series Vertical File 5 Drawer Legal w/Lock Standard Random Key Lock PAINT: Select Core Paint PAINT: Putty	14	\$ 394.33	\$ 5,520.62
64		HON	HN1 .A .H .JM \$(3) .NT 10 .SB .T	Nucleus Mid Back Work Chair Arm: Adjustable Arm Caster: Hard Back: Stretch Black GRADE: III UPHOLSTERY UPH: Tectonic COLOR: Black Base: Standard Plastic Black FRAME: Black	4	\$ 396.21	\$ 1,584.84

Approved _____

Date _____

Quote prices are subject to manufacturer price increases.







QUOTE IS SUBJECT TO FINAL AUDIT

All product is special order and therefore non-returnable and non-refundable.

Orders over \$5000 require credit approval.

Orders over \$20,000 require credit approval and 1/3 deposit.

QUOTE VALID FOR 30 DAYS

Item	Preview	Mfg	Part Number	Part Description	Qty	Sell	Ext Sell
65		GLB	5450-3	TRUFORM-High back multi titer w/ hgt adj arms, ratchet-style back height seat depth adj	1	\$ 305.03	\$ 305.03
			-03 -JENY JN02 SC BK C1 - - -	GRADE 03 JENNY 1-EBONY A-(STD) HGT ADJ SSU F-(STD) BLACK C-(STD) 2" DUAL-WHL CASTOR - BLCK (STD) (STD) (STD) (STD)			
sub				126 Clerks Subtotal			\$ 16,000.88
66		HON	H105892	10500 Series 60Wx30Dx29-1/2H Dbl Ped Dsk 3/2 Rect Top	1	\$ 616.64	\$ 616.64
			.F F	LAM: Shaker Cherry LAM: Shaker Cherry			
67		HON	HVL171	Mid Back Chair;Fixed Padded Loop Arms	1	\$ 95.41	\$ 95.41
			\$(L) .SB 11	GRADE: Leather Upholstery Fabric: Black Leather COLOR: Black 11			
sub				130 Conf Subtotal			\$ 712.05
68		HON	H105900	10500 Series Cred w/Kneespace 72Wx24Dx29-1/2H 2-0-2	1	\$ 617.58	\$ 617.58
			.F F	LAM: Shaker Cherry LAM: Shaker Cherry			
sub				131 Security Subtotal			\$ 617.58
69		HON	HTLCP72	Preside Laminate Curved Panel Base For 72" W Table Tops	2	\$ 252.86	\$ 505.72
			.F	LAM: Shaker Cherry			
70		HON	HTLC3672	Preside 72W x 36D Rectangular Shaped Laminate Top	2	\$ 346.86	\$ 693.72
			.K F .N F	Ribbon LAM: Shaker Cherry No Grommets LAM: Shaker Cherry			
71		GLB	2108	DIPLOMAT-Armless side chair. Four legs. Can be used with ganging clamp - model 6526	13	\$ 168.73	\$ 2,193.49
			-03 -JENY JN02 BK -	GRADE 03 JENNY 1-EBONY F-(STD) BLACK (STD)			

Approved _____

Date _____

Quote prices are subject to manufacturer price increases.





QUOTE IS SUBJECT TO FINAL AUDIT

All product is special order and therefore non-returnable and non-refundable.

Orders over \$5000 require credit approval.

Orders over \$20,000 require credit approval and 1/3 deposit.

QUOTE VALID FOR 30 DAYS

Item	Preview	Mfg	Part Number	Part Description	Qty	Sell	Ext Sell
72		HON	HN1 .A .H .IM \$(3) .NT 10 .SB .T	Nucleus Mid Back Work Chair Arm: Adjustable Arm Caster: Hard Back: Stretch Black GRADE: III UPHOLSTERY UPH: Tectonic COLOR: Black Base: Standard Plastic Black FRAME: Black	1	\$ 396.21	\$ 396.21
73		GLB	5450-3 -03 ~JENY JN02 SC BK C1 - - -	TRUFORM-High back multi titer w/ hgt adj arms, ratchet-style back height seat depth adj GRADE 03 JENNY 1-EBONY A-(STD) HGT ADJ SSU F-(STD) BLACK C-(STD) 2" DUAL-WHL CASTOR - BLCK (STD) (STD) (STD) (STD)	1	\$ 305.03	\$ 305.03
sub				132 Court Room Subtotal			\$ 4,094.17
74		HON	HTLXP48 .F	Preside Laminate Curved Panel X Base for 48" Tops LAM: Shaker Cherry	1	\$ 200.22	\$ 200.22
75		HON	HVL171 \$(L) .SB 11	Mid Back Chair;Fixed Padded Loop Arms GRADE: Leather Upholstery Fabric: Black Leather COLOR: Black 11	4	\$ 95.41	\$ 381.64
76		HON	HTLD48 .K F .N .F	Preside 48" Round Shaped Laminate Top Ribbon LAM: Shaker Cherry No Grommets LAM: Shaker Cherry	1	\$ 293.28	\$ 293.28
sub				133 Lawyer Conf Subtotal			\$ 875.14
77			Fabrication	Labor to receive, deliver, and install HON product is included per NIPA contract qt#1672.	1	\$ 0.00	\$ 0.00
78			Fabrication	Labor to receive, deliver, and install other manufacturer product qt#1672.	1	\$ 784.38	\$ 784.38
				Grand Total			\$ 44,328.45

Approved _____

Date _____

Quote prices are subject to manufacturer price increases.

QUOTE IS SUBJECT TO FINAL AUDIT

All product is special order and therefore non-returnable and non-refundable.

Orders over \$5000 require credit approval.

Orders over \$20,000 require credit approval and 1/3 deposit.

QUOTE VALID FOR 30 DAYS

May 9, 2014

Johnson County JP Courtroom
Alvarado, TX

TO WHOM IT MAY CONCERN

Greetings:

Imperial Woodworks, Inc. appreciates the opportunity to submit this proposal for courtroom benches to be used at the Johnson County JP Courtroom, Alvarado, TX.

17 Pews of various lengths totaling approximately 142 lineal feet
944 Pew style.

Total Base Bid, delivered and installed: \$14,500.00

Option: #90 Chairs \$140 Each

The base bid includes the following:

Materials: Red Oak

Bench Body: #944 all wood body with flat back and contoured seat.

Bench End: #3071SE

Supports: All supports will be evenly spaced on each bench with the distance between supports never exceeding 5'6". Supports made of plywood core with solid red oak edgebanding. All supports 1 1/4" thick.

Finish: Imperial uses a pre-catalyzed lacquer process as a finish for our furniture. This finish is **MAINTENANCE FREE**. No mandatory polishing or other custodial care such as waxing is ever required as a condition of warranty. Only dusting with a barely damp cloth is recommended.

Anchors: Double concealed anchors at each end of the pew are standard. All concrete anchors shall be "Chicago" lead expansion bolts. Red Head bolts are not acceptable.

Wood Color: Choice of manufacturer's standard options

Terms of Payment: See attached.

Our proposal includes delivery and installation as qualified below. Applicable sales taxes, if any, would be in addition to the prices quoted. Delivery is calculated using our tractor and trailer. Off loading of the disassembled benches and placement in the building is included using our non-union labor. Installation of the benches is included, using our non-union labor. Any costs for union labor, union dues, memberships, etc., are not part of this proposal.

Our proposal is subject to review in 30 days. Our price is predicated on delivery of the furniture within 12 months from our receipt of the order, with all details complete.

We look forward to being of service to you and the court. We know you will be completely satisfied with the **QUALITY, COMFORT, AND CRAFTSMANSHIP** of our product and the **INTEGRITY** of our people.

Yours very truly,

IMPERIAL WOODWORKS, INC.



Kevin Smith
Vice President
kevin@pews.com

KMS:gb

Enclosures

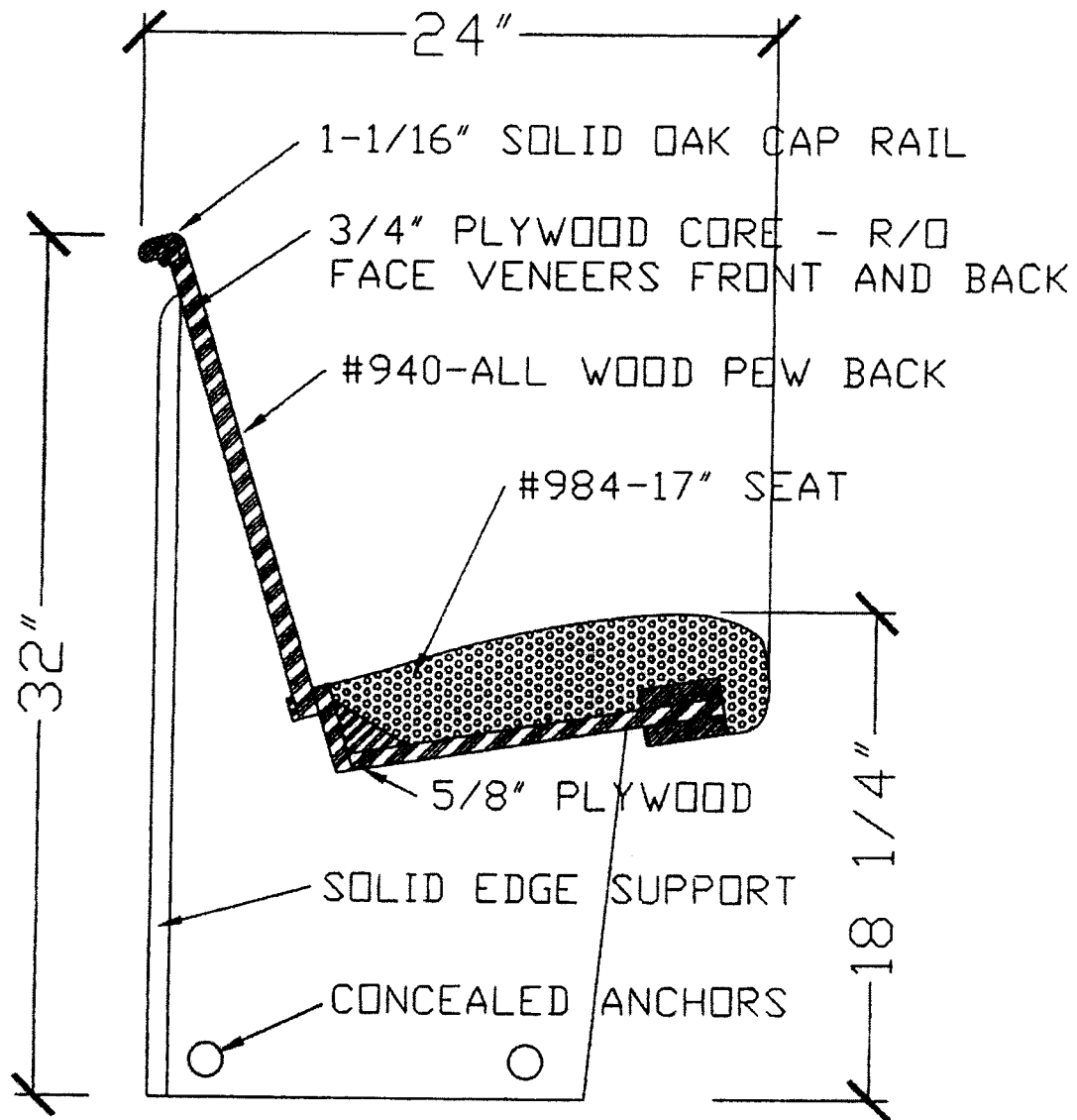

#940-984 PEW BODY SECTION

IMPERIAL WOODWORKS, INC.
 WACO, TEXAS

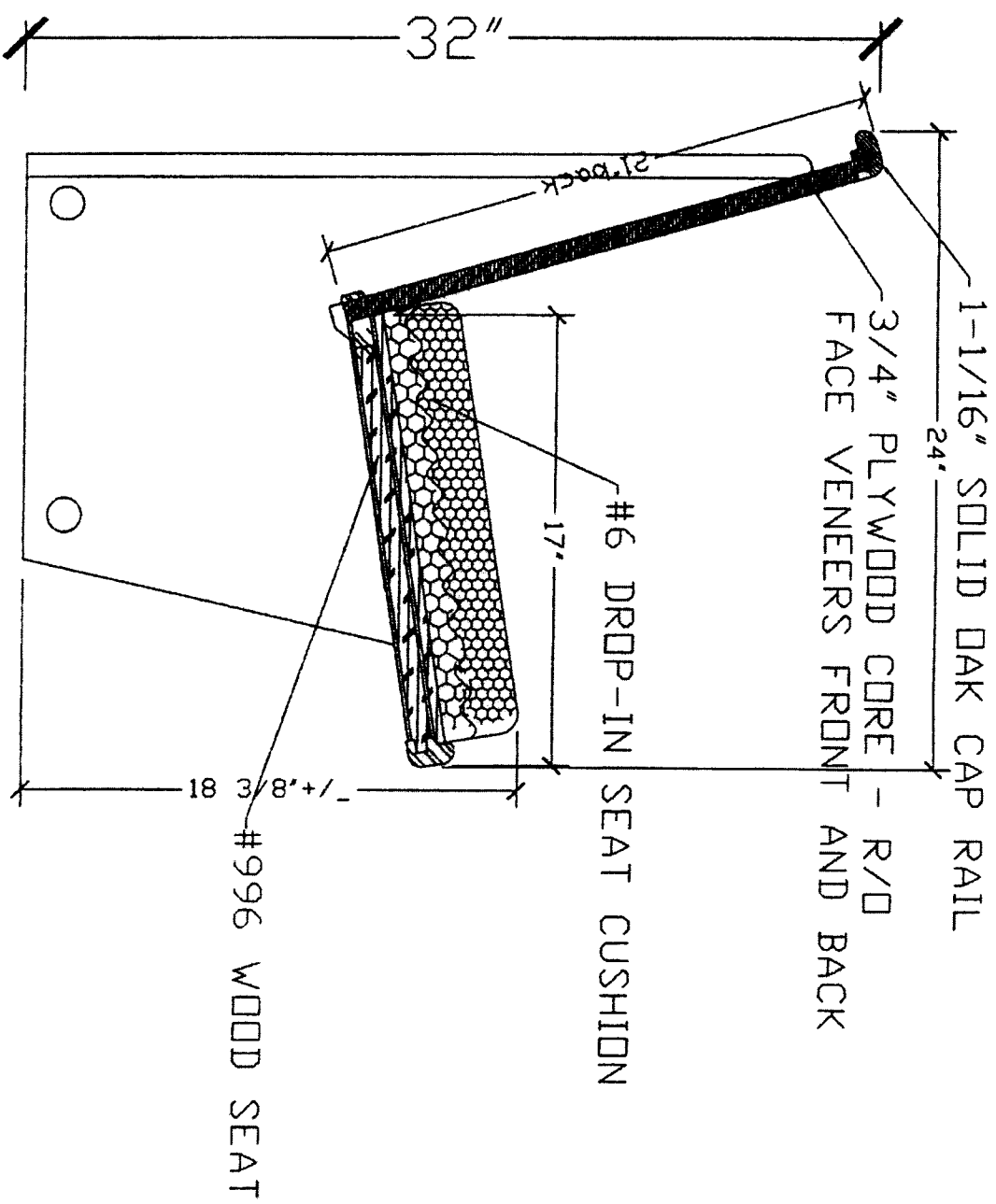

#940XX--21"BACK--#996 SEAT
 W/#6 DROP-IN CUSHION

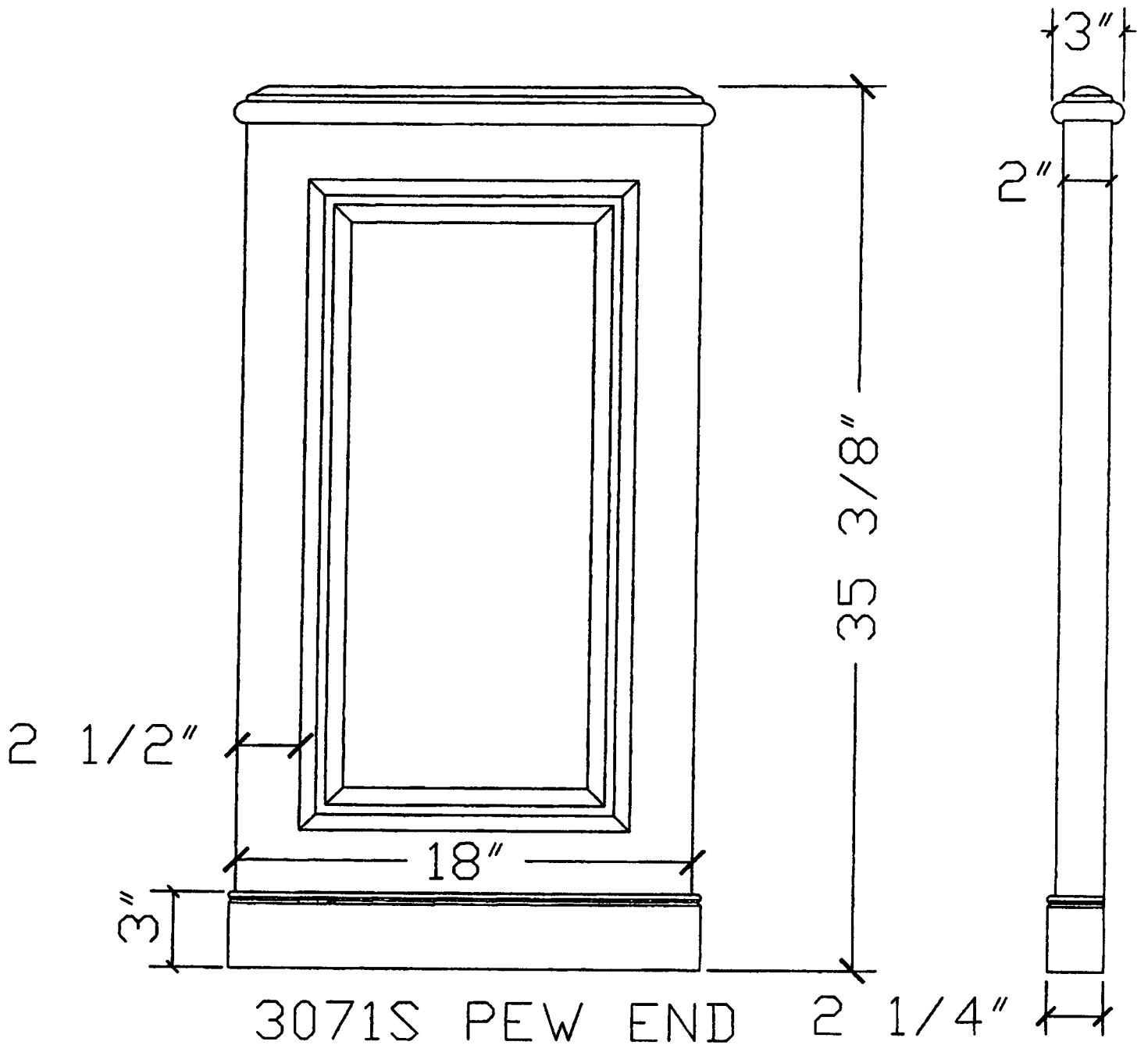

IMPERIAL WOODWORKS, INC.
 WACO, TEXAS

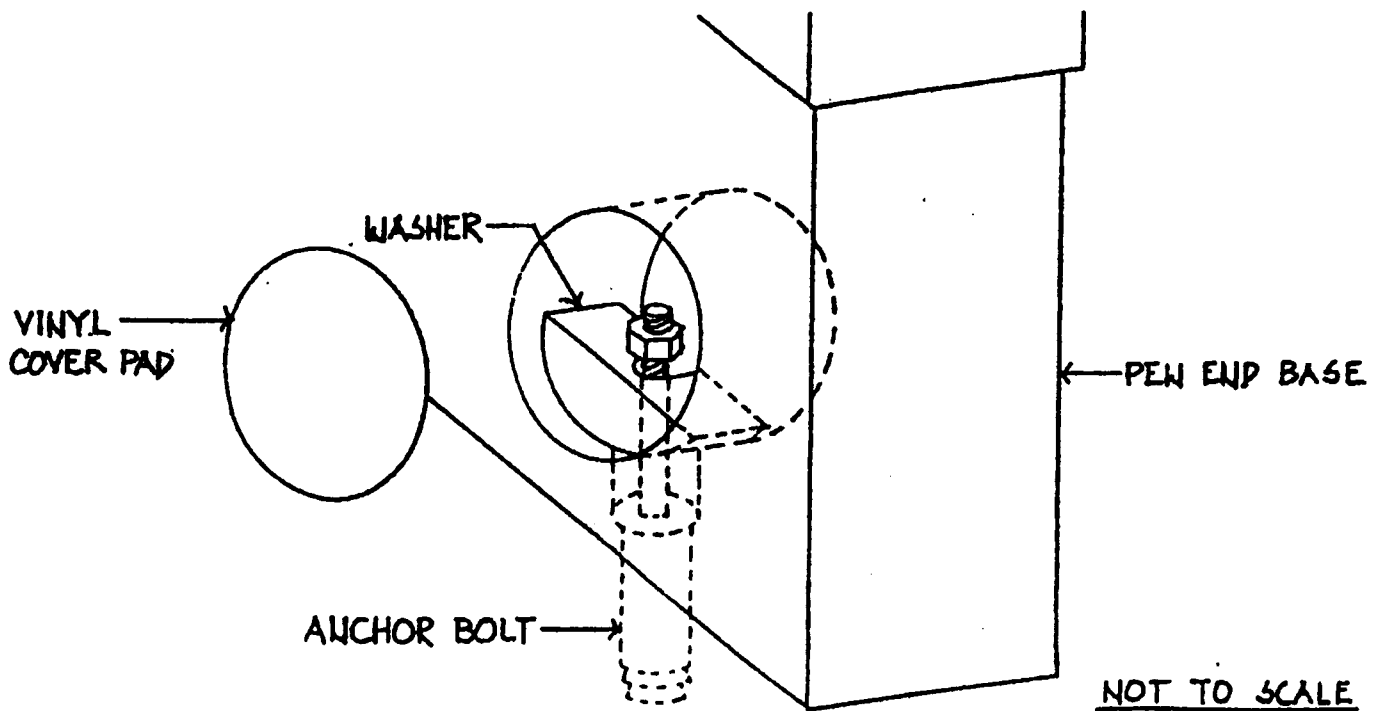
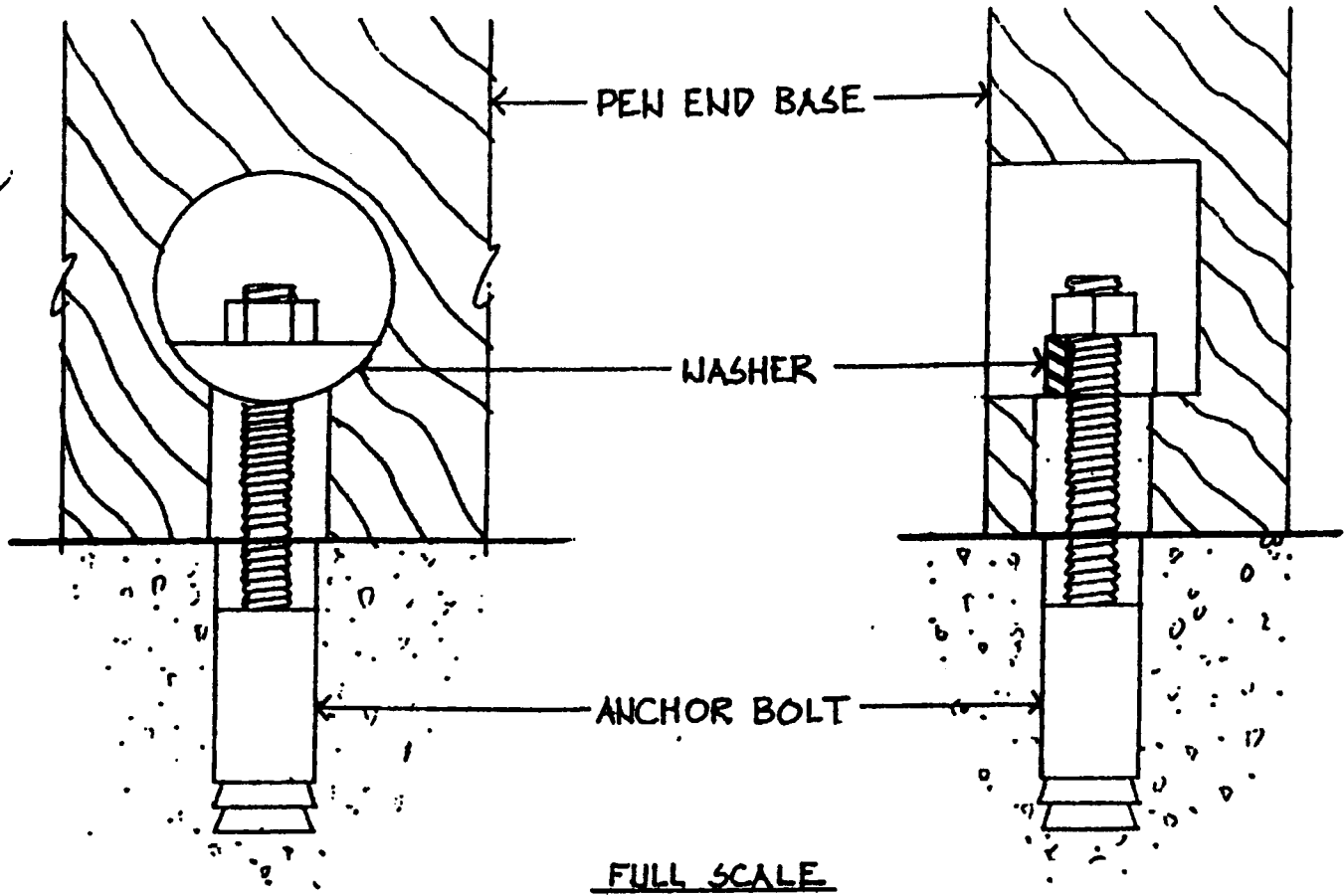

CONCEALED FLOOR ANCHOR FOR CONC. FLOOR

IMPERIAL WOODWORKS, INC. WACO, TX 7-19-84 C

2 ANCHORS PER PEN END BASE



original
type 1100



lifetime
type 2100

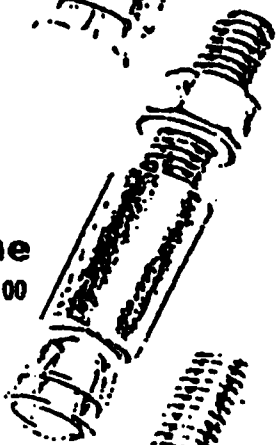

supreme
type 5100

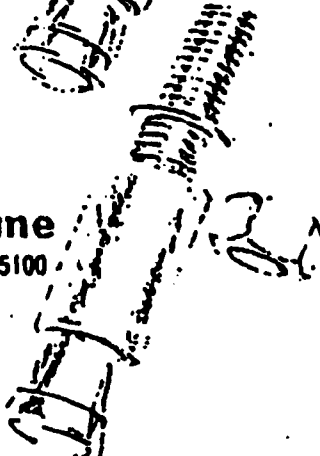

Installation

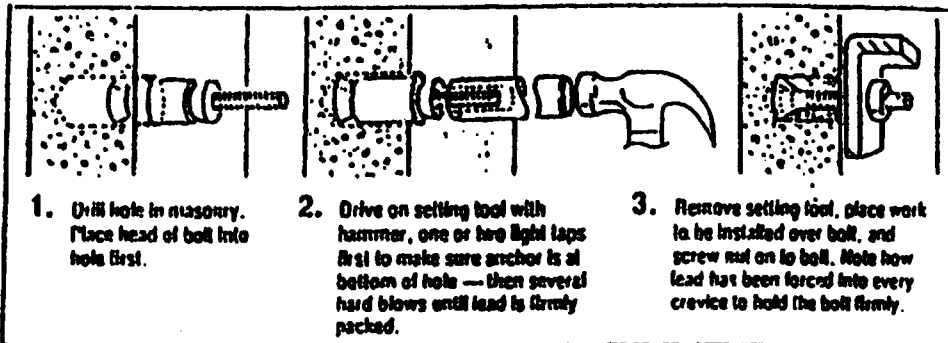

• The CHICAGO Expansion Bolt is a complete anchor including bolt, nut and expansion unit. It comes all assembled, eliminating the need for buying the bolt separately. This is the most practical type of anchor, wherever it is possible to standardize on a few sizes.

ORIGINAL: (Catalog Series Type 1100) The Original CHICAGO Expansion Bolt consists of a taper-headed bolt, lead sleeve, metal cone and nut completely assembled. When installed, the taper-head of the bolt and the metal cone expand the lead sleeve to fill all the pores and crevices of the material in which it is set.

LIFETIME: (Catalog Series Type 2100) They call this the "Expansion Bolt that won't pull out." Its superiority over other anchors comes

from its steel cone which expands over the head of the bolt when set. This, plus an extra long lead sleeve, assures maximum holding power — far beyond normal requirements — up to the tensile strength of the bolt. It is one anchor that won't pull out. It is especially effective in over-size holes. Vibration cannot loosen the Lifetime and it will not damage the face of masonry.

SUPREME: (Catalog Series Type 5100) Same design as Lifetime except for the packaging method. To save time and speed installation, CHICAGO SUPREME Expansion Bolts are packed in this container which holds the assembled bolts in upright position convenient to pick up and drop in the hole. The nuts are packed in a separate box at one end of the container for ready use.

Size	type 1100		type 2100		type 5100		Dia.	Min Depth	Std. Box	Std. Ctn.
	Cat. No.	Lbs. Wt./C	Cat. No.	Lbs. Wt./C	Cat. No.	Lbs. Wt./C				
1/8 x 1 1/2	1120-00	6 1/2	2120-00	7 1/2	5120-00	7 1/2	1/2"	1'	100	500
1/8 x 1 3/4	1121-00	6 3/4	2121-00	8	5121-00	8				
1/8 x 2	1122-00	7	2122-00	8 1/2	5122-00	8 1/2				
1/8 x 2 1/2	1124-00	7 1/2	2124-00	9 1/2	5124-00	9 1/2				
1/8 x 3	1125-00	8	2125-00	9 1/2	5125-00	9 1/2				
1/8 x 3 1/2	1127-00	8 1/2	2127-00	9 1/2	5127-00	9 1/2	1/2"	1 1/4"	50	250
1/8 x 4	1129-00	9	2129-00	10 1/2	5129-00	10 1/2				
3/8 x 2 1/2	1140-00	15 1/2	2140-00	16 1/2	5140-00	16 1/2				
3/8 x 3	1141-00	17	2141-00	18	5141-00	18				
3/8 x 3 1/2	1142-00	18 1/2	2142-00	19 1/2	5142-00	19 1/2				
3/8 x 4	1143-00	19 1/2	2143-00	20 1/2	5143-00	20 1/2	1/2"	2'	25	125
3/8 x 4 1/2	1145-00	20 1/2	2145-00	21 1/2	5145-00	21 1/2				
3/8 x 5	1147-00	22	2147-00	23	5147-00	23				
3/8 x 6	1149-00	23 1/2	2149-00	24 1/2	5149-00	24 1/2				
1/2 x 3	1160-00	42 1/2	2160-00	42 1/2	5160-00	42 1/2				
1/2 x 3 1/2	1161-00	45	2161-00	45	5161-00	45	1/2"	2'	25	125
1/2 x 4	1162-00	47 1/2	2162-00	47 1/2	5162-00	47 1/2				
1/2 x 6	1163-00	57 1/2	2163-00	57 1/2	5163-00	57 1/2				

Depth given in Drilling Tables is for Average Concrete. In poor Materials, Drill Deeper and use EXTRA Lead and Cones.



setting tool
for caulking Expansion Bolts is included in each box.

Maytag 20.6 cu. ft. Top Freezer Refrigerator in Stainless Steel

Model # M1TXEGMYS Internet# 202851660 Store SO SKU # 624494



★★★★ 4.2/5 1,227 Reviews

\$899.10 / each
Was ~~\$999.00~~

Save \$99.90 (10%) ^

Item qualifies for current 10% off Appliance Offer.
Online price above includes discount. While supplies last.
Price Valid: 06/01/2014 - 06/04/2014

Order online or in-store

FREE Delivery & Haul Away
Your delivery date will not be secured until you select a date during checkout and complete your order.

Item cannot be shipped to the following state(s):
AK, GU, HI, PR, VI

Description: v

[View full product details](#)

sears

Customer Service: 1-800-697-3277

sign in | join for free | set location

Stack-On 28 Gun Fire Rated/Waterproof Safe

0 Reviews Description Specifications



On Sale

Sold by: Sears
or 1 other seller

Regular price ~~\$1059.00~~
Your savings ~~-\$53.00~~

\$1006.99

earn \$10.07 in points
to use later

In Stock for Shipping
enter ZIP code for pricing

Store Pickup Not Available

Quantity: 1 **Add to Cart**

Layaway not available

[View Alaska/Hawaii Pricing](#)

Description

Item # 00648459000P Model # TD-28-SB-C-S-DS

Keep Your Firearms Safe and Secure with this 28 Gun Safe

The **Stack On 28 gun fire rated waterproof safe** provides a convenient and durable place to keep your gun collection. Complete with a combination lock and door storage, this gun safe is sure to keep you possessions safe from water and fire damage.

A28 gun safe has the storage space a gun enthusiast needs to keep his firearms safe. Just think of the peace of mind.

- The **Stack On 28 gun fire rated waterproof safe** is fully convertible
- Fire rated and waterproof for added protection
- Combination lock and door storage

Specifications

Dimensions:

Overall Dimensions: 28.5"D x 60.5"H x 30.5"W

Product Overview:

Fireproof: Yes
 General Warranty: 5 years
 Item Weight (lbs.): 562
 Keypad Lockout: Yes
 Number of Hours of Fire Protection: 0.3
 Product Type: Fire safe
 Water Proof: Yes

Color:

Color/Finish: Green, gray, and black

Installation Requirements:

Assembly Required: Fully Assembled

Safe Design:

Number Of Shelves: 6
 Security Access: Combination lock

Shelves & Storage:

Adjustable Shelving: Yes

Package Includes:

Package Contents: Bolt Down Kit, Hardware



Stack-On Safes
 Stack-On Safes
 All Stack-On

Frequently Bought Together

This product:

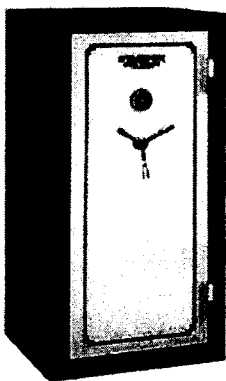

Stack-On 28 Gun Fire
 Rated/Waterproof Safe

\$1006.99

Ratings & Reviews

0 Reviews have been submitted for this product

